

SONY

DIGITAL VIDEO CAMERA

Equipped with the Global Shutter CMOS Sensor

Sony is adding a new series of the USB3 Vision interface digital cameras equipped with a global shutter CMOS sensor to the Machine Vision product line.

These cameras achieve 1.6MP, 100fps in a compact 29(W) x 29(H) x 30(D)mm size.

This series is ideal for replacing older analog camera models. Both cameras inherit analog camera size and reliability and combine excellent system construction with feature rich, cost-effective performance.

Easy plug and play use through a PC connection.



USB3 Vision

XCU-CG Series

1/2.9-type 1.6MP 100 fps

XCU-CG160 (B/W)

XCU-CG160C (Color)

Pregius

Exmor



Cubic Size

- Dimensions : 29 (W) × 29 (H) × 30 (D) mm *excluding protrusions
- Identical dimensions and attachment method as cubic series analog cameras

Feature-rich

- Area gain
- Defect correction
- Shading correction
- Temperature readout
- Look Up Table (LUT)
- Multi ROI
- 3 x 3 filter
- Binning *Only XCU-CG160

Easy Connection

- Plug and Play

Easy analog cameras Migration

- SXGA and VGA output are available
Through the use of binning, VGA output is also available with same angle of view.
Sensitivity is also increased.
- Easy expansion from VGA to SXGA
In consideration of future changes to SXGA cameras, replacement is easy allowing you to reduce development time.

USB3 Vision Features

The USB 3.0 (also known as USB3.1 Gen1) has transmission speeds of up to 5 Gbps which allows real-time delivery of uncompressed image data.

Known for plug and play, ease of use USB3 Vision cabling is optimized for machine vision use by adopting a secure cable that can withstand high vibration environments.

USB3 Vision uses the GenICam API device description for camera control which is the same as GigE Vision and CameraLink 2.0. This allows an easy switch of assets created for other standards.

Stability

- Maximum 350MB/sec data transfer speed
- Real-time bulk transfers

Expandability

- Ensured future expansion

Robustness

- Secure connectivity for demanding environments

Others

- Cable length: 3m* (standard passive copper wire)
- Power supply: Standard passive cable, Maximum 4.5W
- Easy application switch with other I/F cameras such as GigE Vision

*Contact your Sony representative for details on cable length.

Features

High Frame Rate

Select either "Frame rate priority" or "Full feature available" mode.

Model	Frame rate priority Fast		Full feature available Normal	
	Raw 8 bit	100 fps	Raw 8/12 bit	56 fps
XCU-CG160 XCU-CG160C			YCbCr422	49 fps
			RGB YCbCr444	32 fps

Burst Trigger

This is a feature capable of continuous shooting at the trigger timing and specifying the number of exposures, exposure interval, and exposure time.

Select between the mode that repeats one exposure time or the mode that switches between 2 exposure times repeatedly. Furthermore, there is another mode that repeats only while the trigger signal is on.

[Merits]

- Optimal for capturing synchronized images with several cameras
- Optimal when 2 exposures are necessary due to the difference in brightness of the subject

(A) When 1 pattern of exposure time is set

Set the number of exposures (1), exposure interval (2), and exposure time (3)

Continuous shooting at the trigger timing

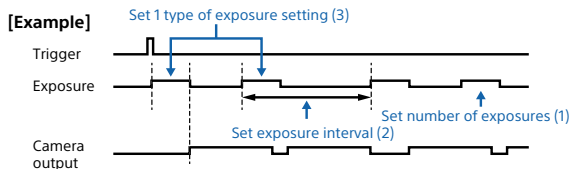

(B) When 2 patterns of exposure times are set

Set the number of exposures (1), exposure interval (2), and exposure time (3)

Continuous shooting at the trigger timing

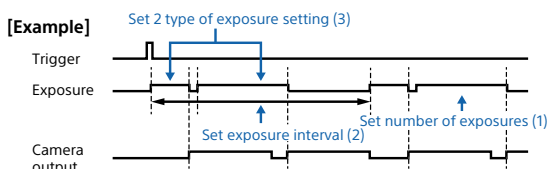

Multi ROI

Arbitrarily read out images including any 2 (max.) rectangular area from the maximum effective imaging area. Due to this, you will be capable of limiting read out information, thus accelerating the frame rate.

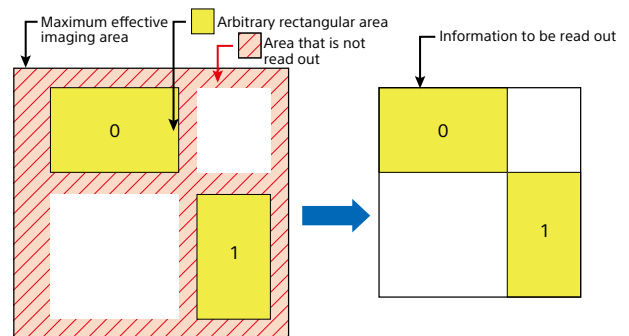

Area Gain

Individually set digital gain (0 to 32 times) to any of the 16 rectangular areas.

If several rectangular areas overlap, the gain value of the rectangular area with a smaller area number is prioritized. Optimization of images for parts is available during parts inspection, etc.

When area gain is OFF

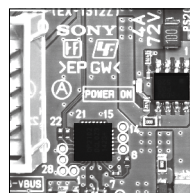

*Sample image

When area gain is ON

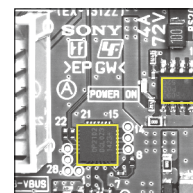

*Sample image

In case setting Gain=2 at Area 0 and Area 1

Features

Binning

*only XCG-CG160

Supports binning in vertical and horizontal 2 pixel units and increases frame rate without changing the angle of view as well as enhances the sensitivity.

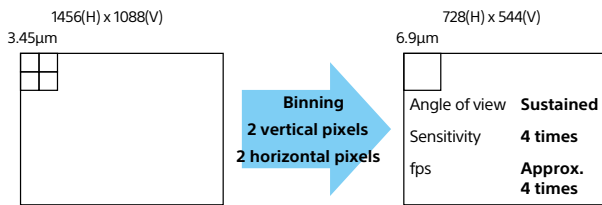
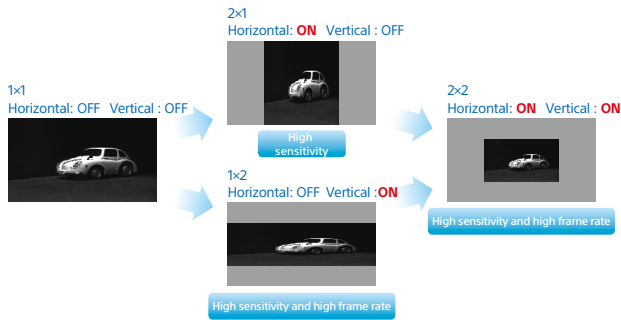

*However, valid for sufficiently short exposure time settings since it is set to exposure time priority

Other Features

Trigger Range Limitation

You can choose to receive only the signal of the set trigger width as a trigger signal. It functions as a noise filter that eliminates chattering and disturbance noise of the trigger signal line. Furthermore, exposure start can be delayed following the set value of the trigger range if a trigger signal is input.

Defect Correction

Corrects white defect points and black defect points of the image sensor. Corrections start from the periphery of the pixel coordinates where defects were detected. Select between factory default settings and user settings.

3 x 3 Filter

Apply various processing to the image through matrix operating in 3 x 3 pixels. Perform processing including noise reduction, edge emphasizing, and contour extraction with 9 filter factor patterns.

Shading Correction

Corrects shading that occurs due to peripheral light falloff, light source irregularity, etc. that are characteristics of the lens. A number of user data can be saved as user settings. XCU-CG160/CG160C : 31 patterns

Pregius

Pregius is a trademark of Sony Corporation. The Pregius is global shutter pixel technology for active pixel-type CMOS image sensors that use Sony's low-noise CCD structure, and realizes high picture quality.

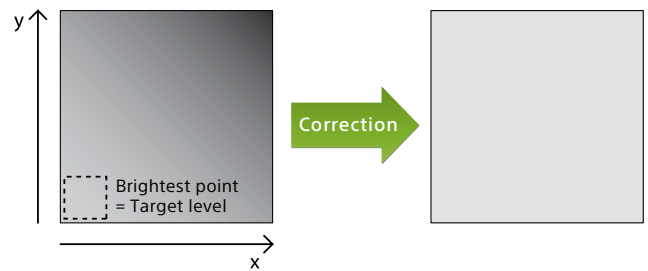
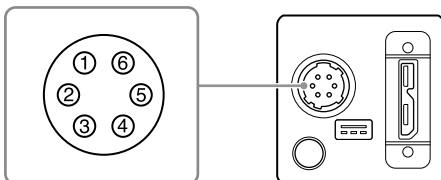

Image Flip

Images can be flipped vertically, horizontally, or 180°.

	ReverseX		
	False(0)	True(1)	
ReverseY	False(0)	Normal	Horizontal flip
	True(1)	Vertical flip	180° rotation

Connector Pin Assignments



Pin No.	Signal	Pin No.	Signal
1	DC input (10.5 V to 15 V)	4	GPO3 (ISO +)
2	GPI1 (ISO +)	5	ISO -
3	GPI2/GPO2	6	GND

Dimensions

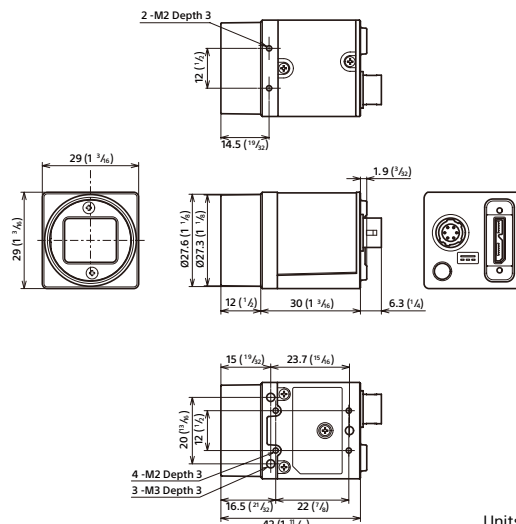

Units: mm (inches)

Specifications

	XCU-CG160	XCU-CG160C
Basic specifications		
B/W/Color	B/W	Color
Image Size	1.6Mega	
Image Sensor	1/2.9-type CMOS Image sensors with global shutter function (Pregius)	
Number of Effective Pixels (H x V)	1,456 x 1,088	
Cell Size (H x V)	3.45 μm x 3.45 μm	
Standard Output Pixels (H x V)	1,440 x 1,080	
Color Filter	-	RGB color mosaic filter
Frame Rate	100 fps (8 bit, Mono/Raw)	
Minimum Illumination	0.5 lx (Iris: F1.4, Gain: +18 dB, Shutter: 1/30 s)	12 lx (Iris: F1.4, Gain: +18 dB, Shutter: 1/30 s)
Sensitivity	F5.6 (400 lx, Gain: 0 dB, Shutter: 1/30 s)	F5.6 (2000 lx, Gain: 0 dB, Shutter: 1/30 s)
SNR	More than 50 dB (Lens close, Gain: 0 dB, 8bit)	
Gain	Auto, Manual: 0 to 18 dB	
Shutter Speed	Auto, Manual: 60 to 1/100,000 s	
White Balance	-	Manual, One push, Auto
Main features		
Readout Modes	Normal, Binning (1 x 2, 2 x 1, 2 x 2), Partial scan (Multi ROI)	Normal, Partial scan (Multi ROI)
Readout Features	LUT (Binarization, Gamma (Arbitrary value settable)), Test pattern	
Synchronization	Hardware trigger, Software trigger	
Trigger Modes	OFF (Free run), ON (Edge detection, Trigger width detection), Burst trigger	
Userset	16	
User Memory	64 bytes x 16 ch	
Partial Scan	W (Pixel)	16 to 1,456
	H (Line)	16 to 1,088
GPO	EXPOSURE / Strobe / Sensor readout / Trigger through / Pulse generation signal / User defined 1, 2, 3 (Output switching)	
Other Features	Area gain, Shading correction, Defect correction, Temperature readout, LUT, 3 x 3 filter	
Interface		
Video Data Output	digital Mono 8, 12 bit (at the time of shipment : 8 bit)	digital Raw 8, 12 bit (at the time of shipment: Raw 8 bit) RGB, YCbCr422, YCbCr444
Digital Interface	USB3.0 (super speed only)	
Camera Specification	USB3 Vision® Ver.1.0.1 compliant	
Digital I/O	ISO IN (x1), ISO OUT (x1), TTL IN/OUT (x1, selectable)	
General		
Lens Mount	C mount	
Flange Back	17.526 mm	
Power Requirements	DC +12V (10.5V to 15.0V), USB bus power (DC +5V ± 5%)	
Power Consumption	DC +12 V 3.5W	
	USB bus power 3.0W	
Operating Temperature	-5°C to +45°C (23°F to 113°F)	
Performance Guarantee Temperature	0°C to 40°C (32°F to 104°F)	
Storage Temperature	-30°C to +60°C (-22°F to +140°F)	
Operating Humidity	20% to 80% (no condensed)	
Storage Humidity	20% to 80% (no condensed)	
Vibration Resistance	10 G (20 Hz to 200 Hz, 20 minutes for each direction -x, y, z)	
Shock Resistance	70 G	
Dimensions (W x H x D)	29 x 29 x 30 mm (excluding protrusions) 1 ³ / ₁₆ x 1 ³ / ₁₆ x 1 ³ / ₁₆ inches (excluding protrusions)	
Mass	Approx. 50 g (Approx. 1.8 oz)	
MTBF	67,447 hours (Approx. 7.7 years)	
Regulations	UL60950-1, FCC Class A, CSA C22.2-No.60950-1, IC Class A Digital Device, CE: EN61326-1 (Class A), AS EMC: EN61326-1, VCCI Class A, KCC, CU-TR EAC: EN61326-1 compliant	
Supplied Accessories	Lens mount cap (1), Operating instructions (1)	

Distributed by

©2018 Sony Imaging Products & Solutions Inc.
 Reproduction in whole or in part without written permission is prohibited.
 Features and specifications are subject to change without notice.
 The values for mass and dimension are approximate.
 "SONY" is a registered trademark of Sony Corporation.
 Pregius and Exmor R are trademark of Sony Corporation.
 All other trademarks are the property of their respective owners.
 Please visit Sony's professional website or contact your Sony representative for specific models available in your region.